

NANCY 001

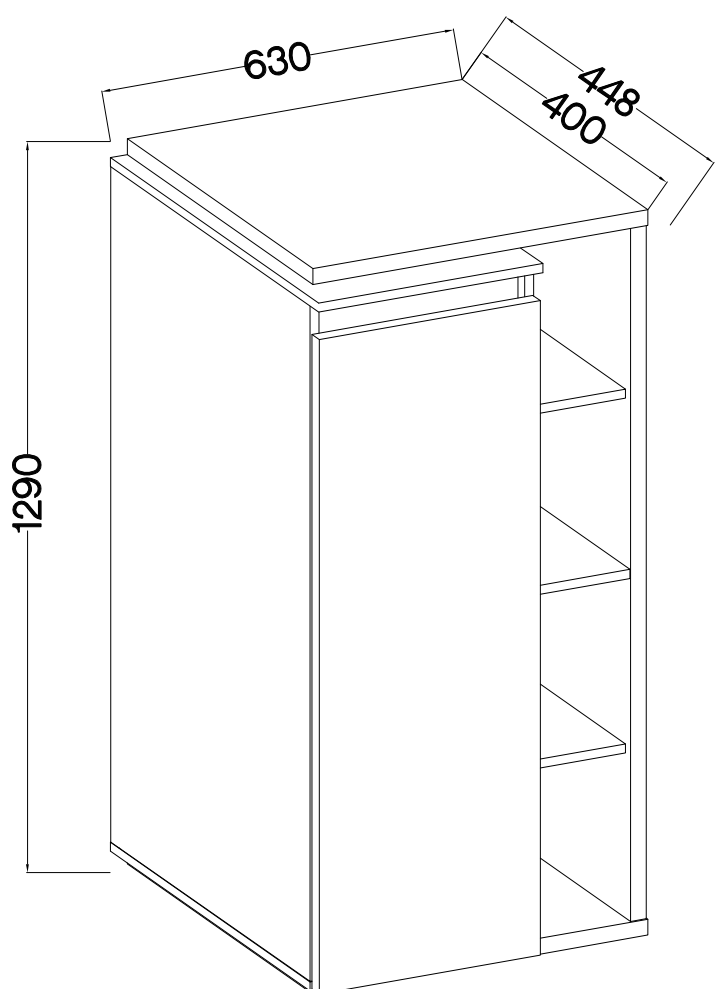

 A	 B	 C	 D2	 ant. E	 szar. E	 E1	 E13			
28	1	22	22	12	10	1	2			
 F28	 HG	 J3	 L	 L9	 O	 O7	 P1	 P5	 P7	 P25
4	3	12	8	1	1	1	8	7	3	4

ISM-NOA-003

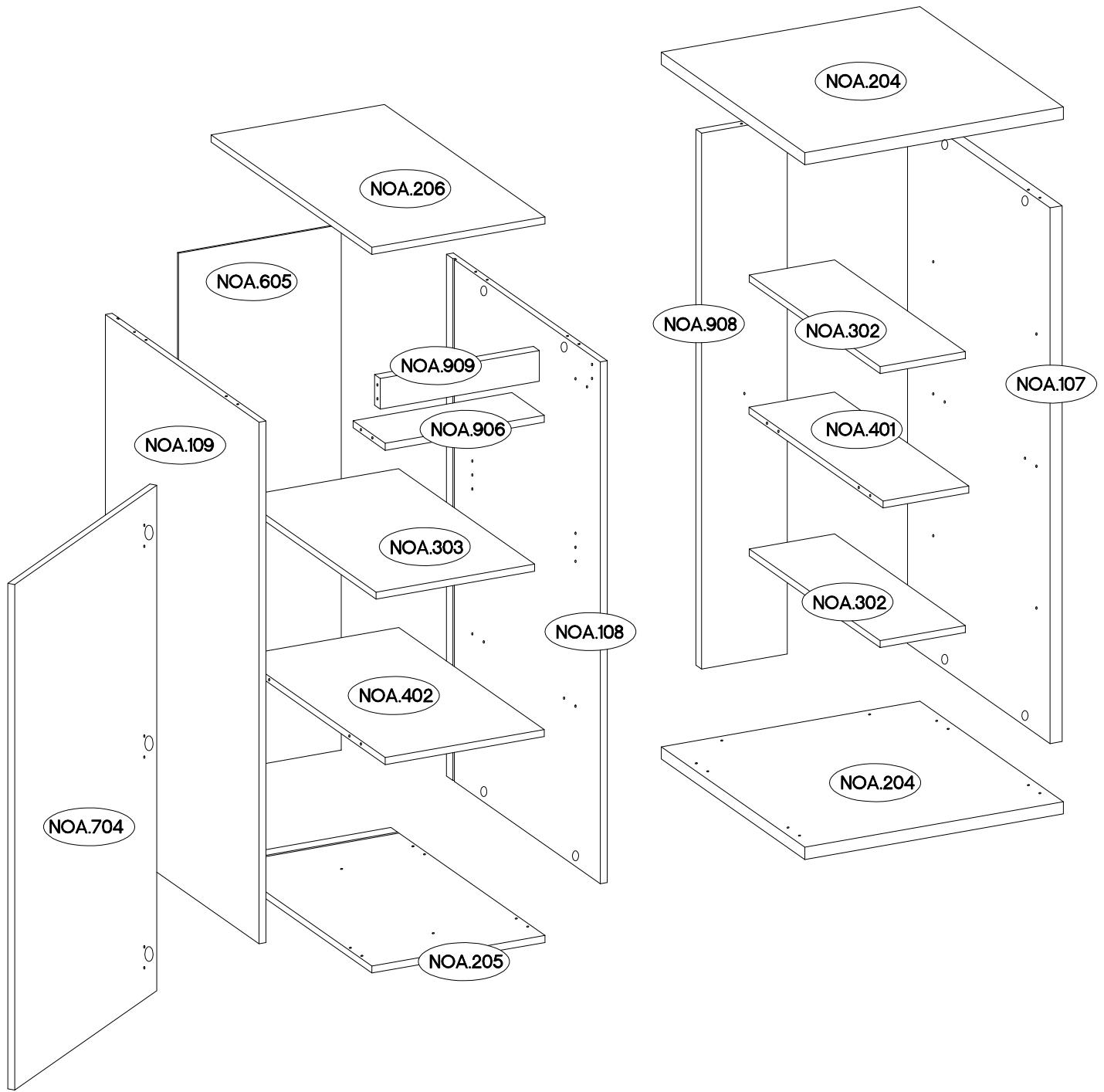

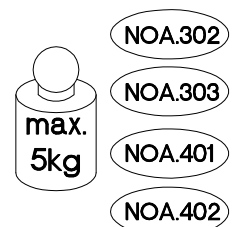

Colli	Ersatzteil Nummer	Dimension
1/2	NOA.108	1192x429x16
	NOA.109	1192x429x16
	NOA.205	402x430x16
	NOA.206	402x448x16
	NOA.302 x2	198x365x16
	NOA.303	368x380x16
	NOA.401	199x374x16
	NOA.402	369x406x16
	NOA.604	1201x378x2,5
	NOA.906	369x90x16
NOA.909	369x70x16	

Colli	Ersatzteil Nummer	Dimension
2/2	NOA.107	1224x398x28
	NOA.204 x2	600x400x28
	NOA.704	1155x396x16
	NOA.908	1224x199x16



1

 A 20	 D2 14	 C 12
$\varnothing 8 \times 30 \text{mm}$	$L = 20 \text{mm}$	$\varnothing 15 / 12 \text{mm}$

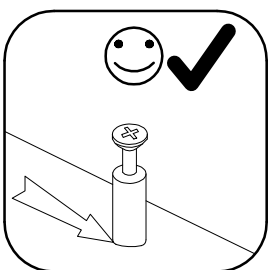
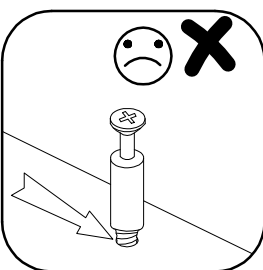
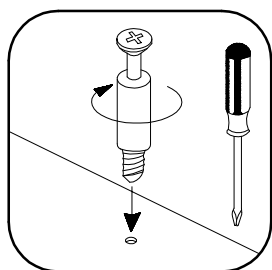
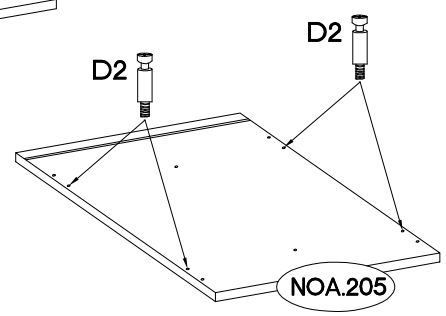
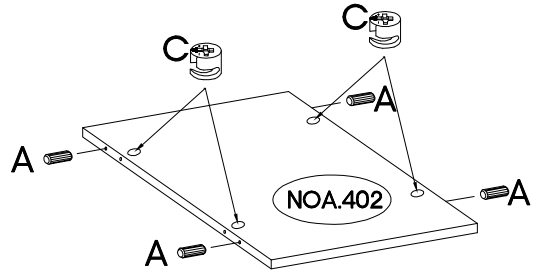
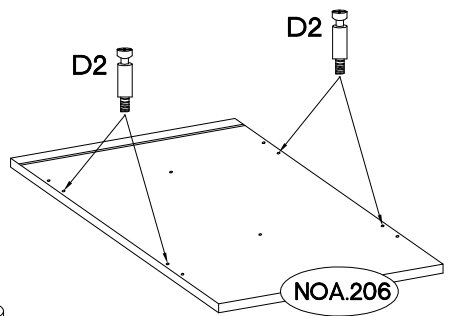
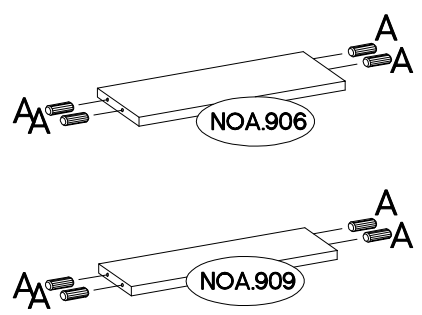
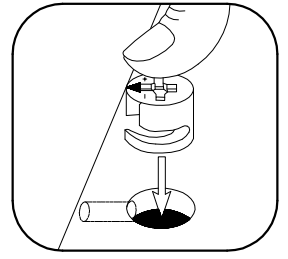
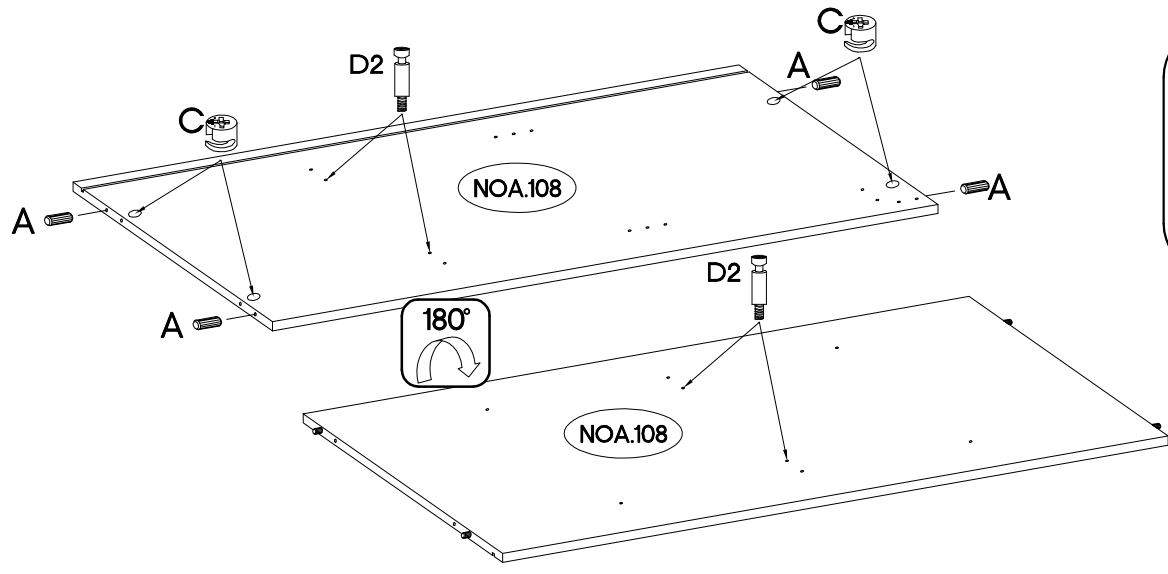
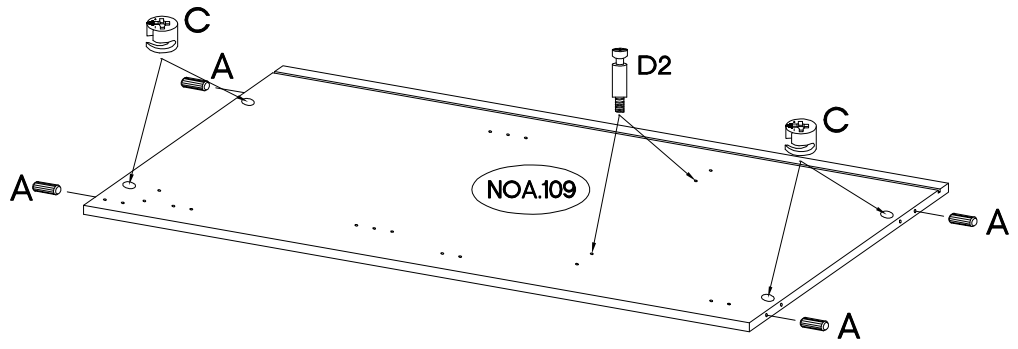
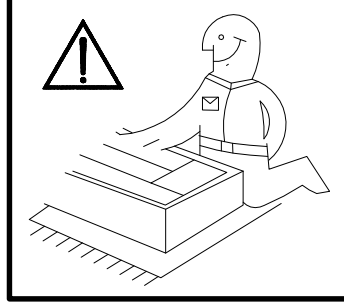
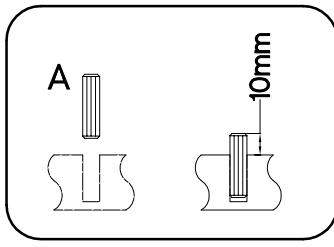

2

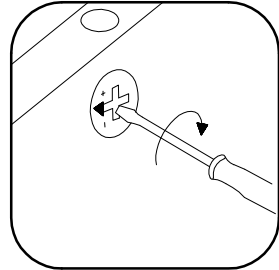
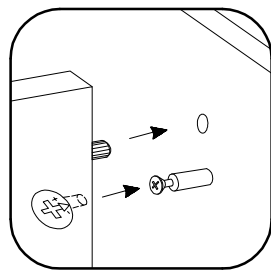
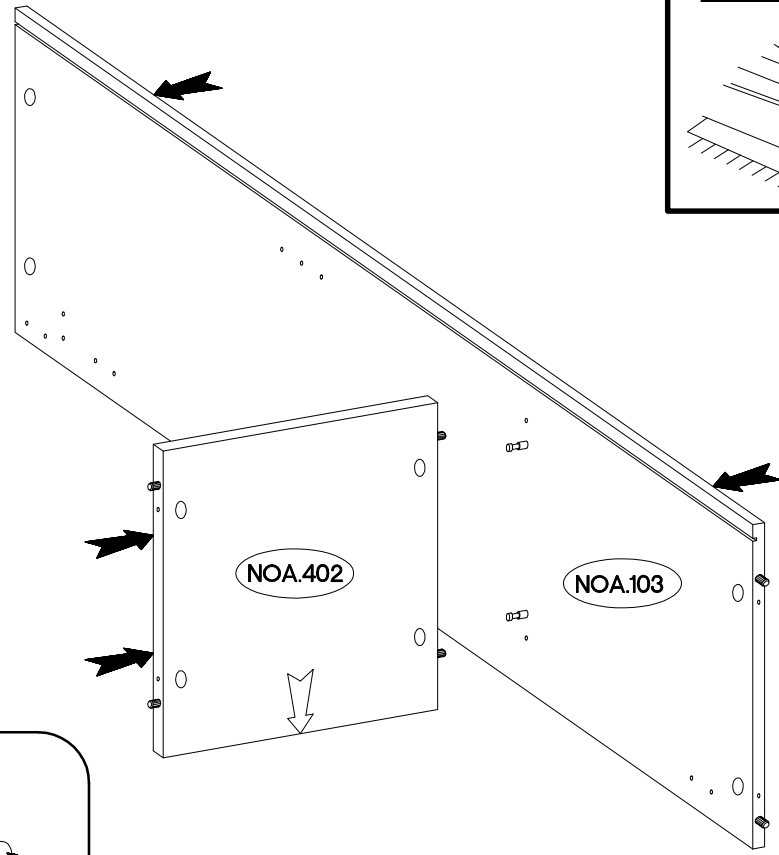
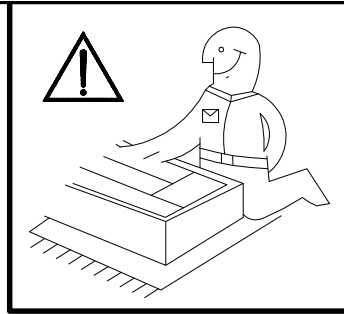

3

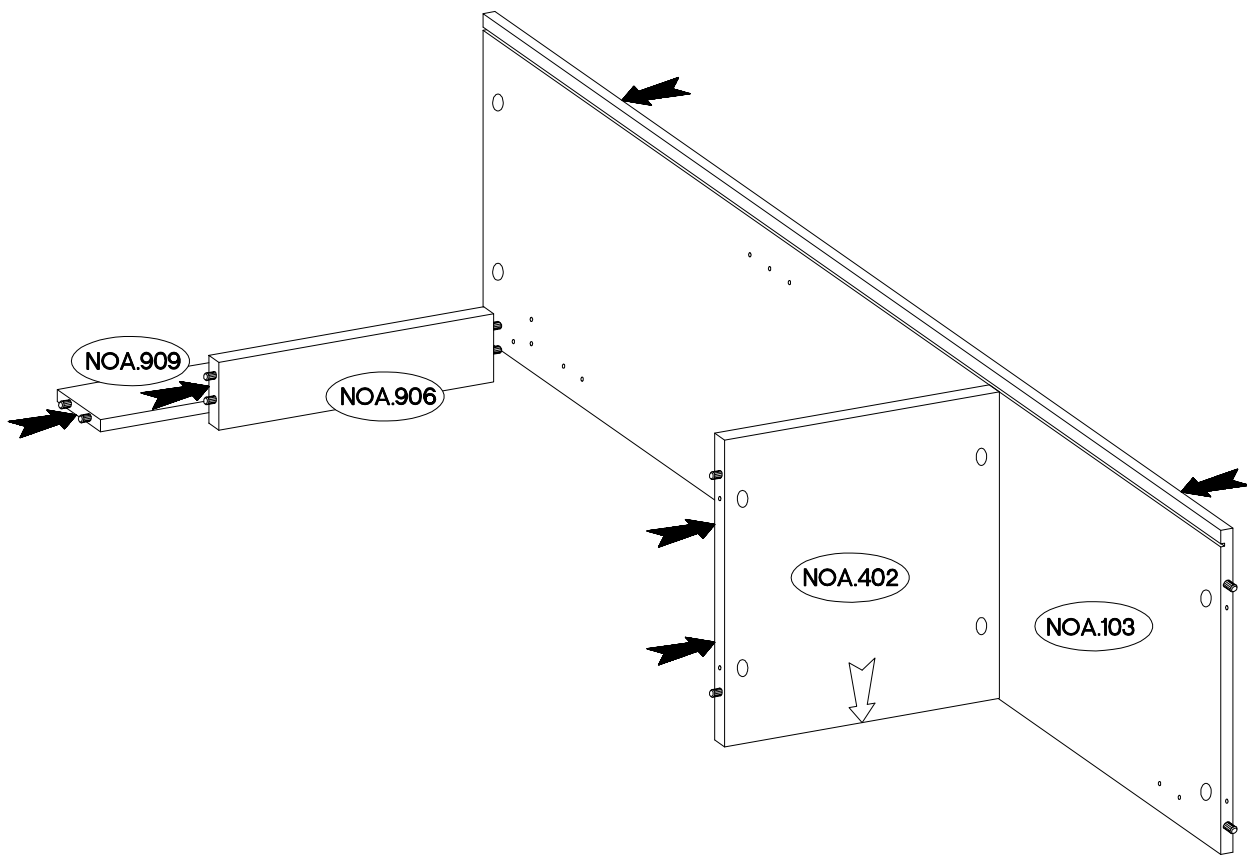

4

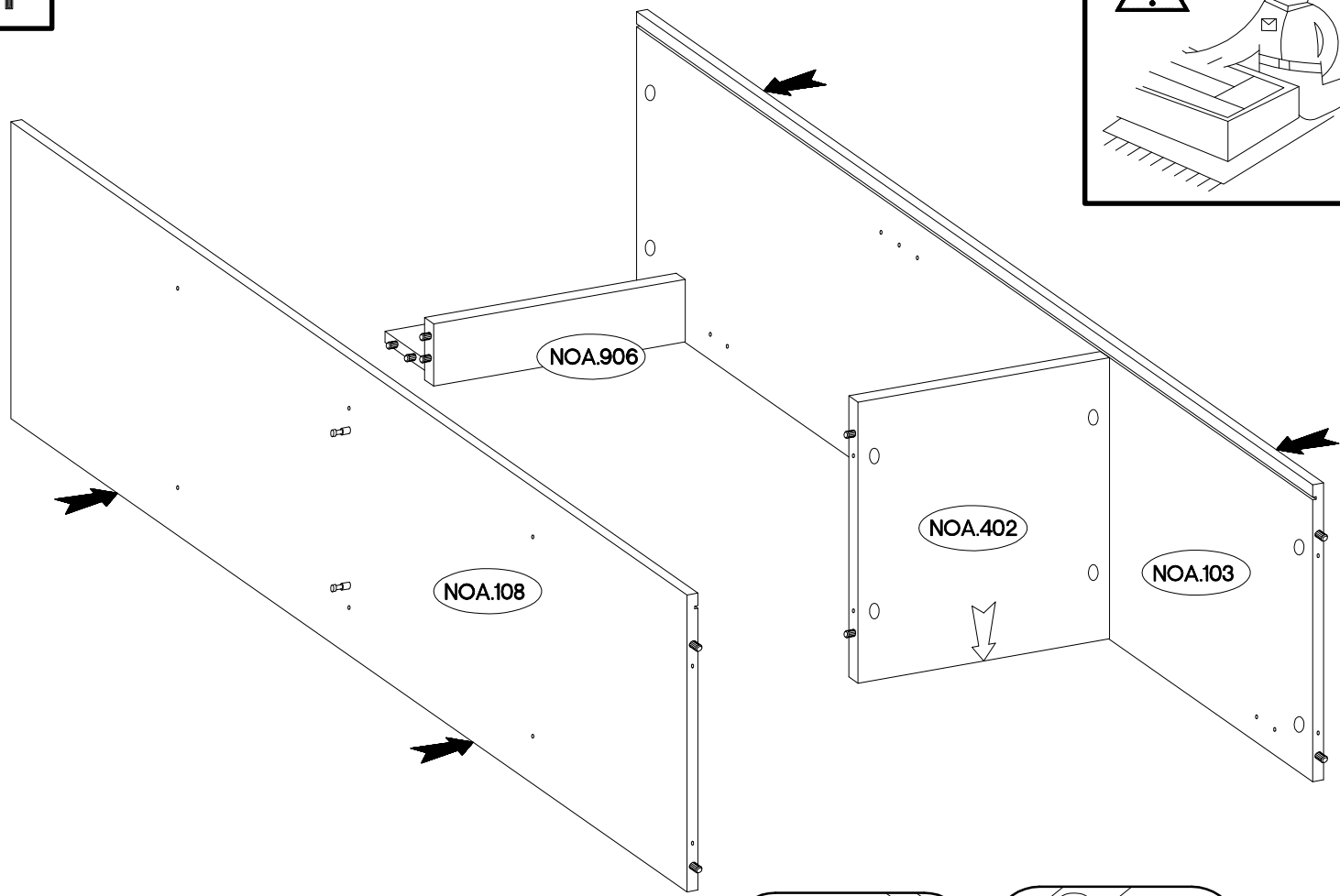
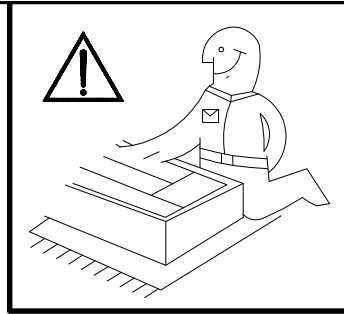

5

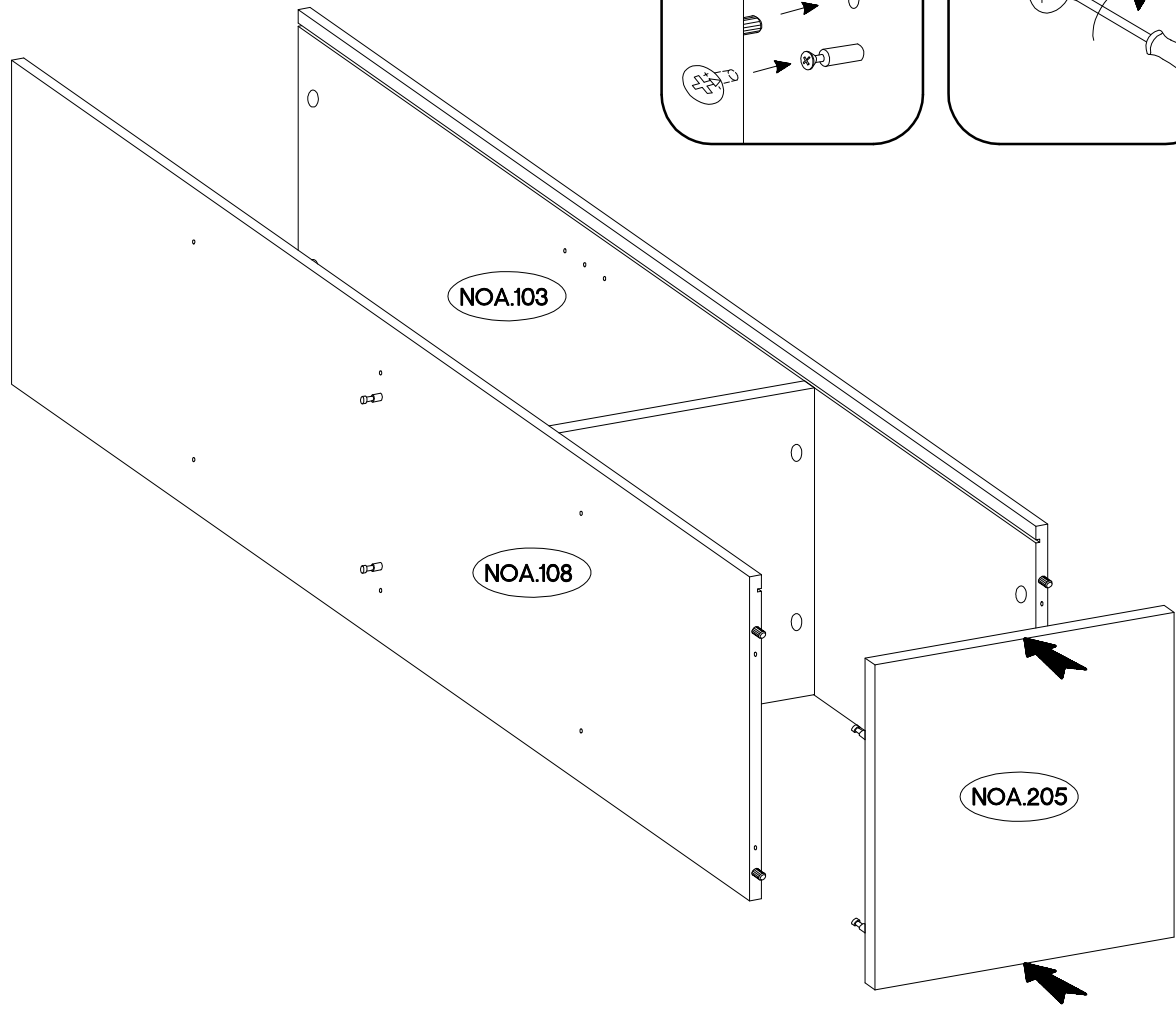
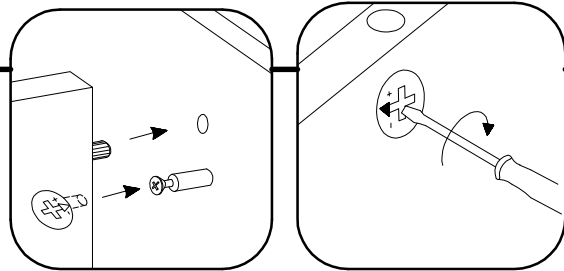

6

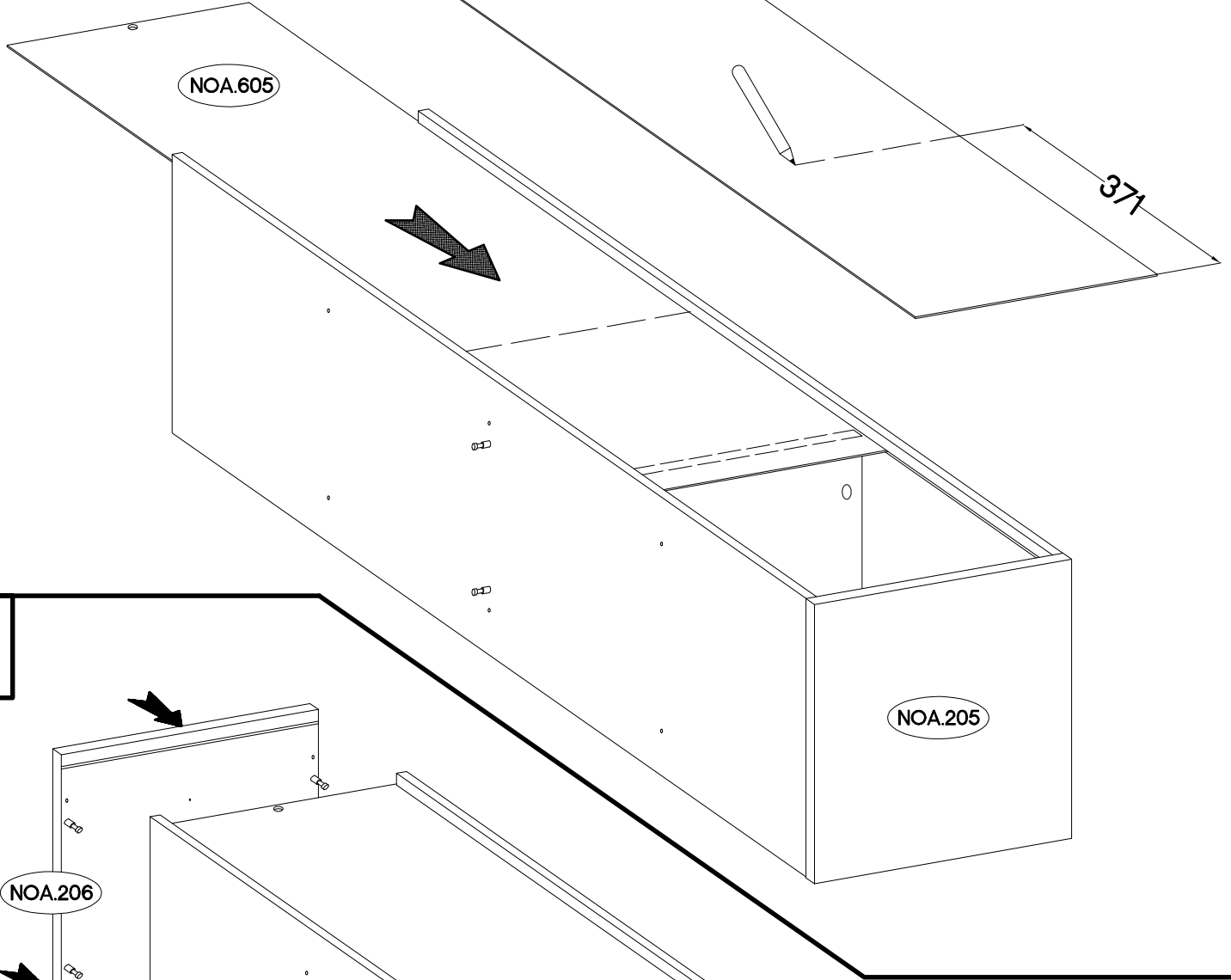
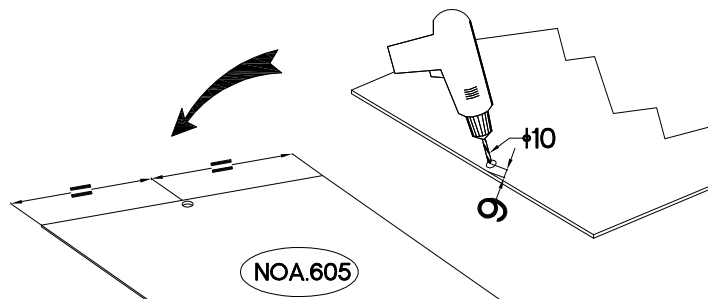

7

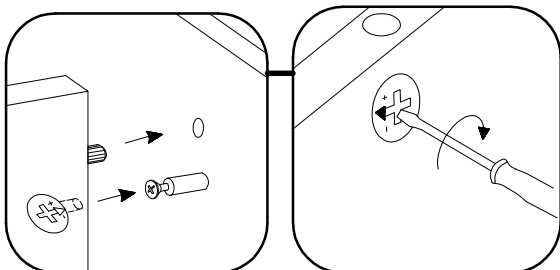
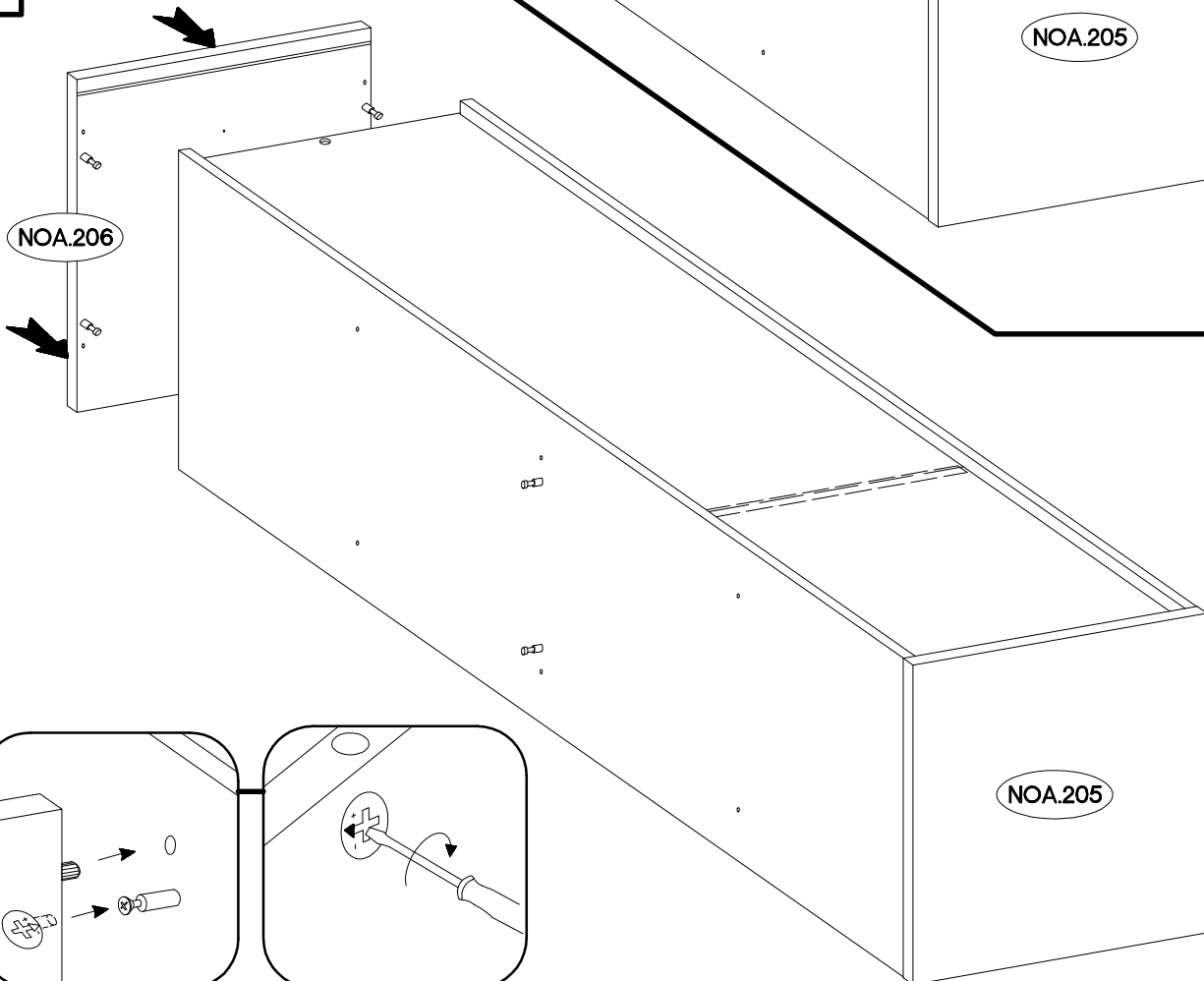

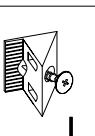

8

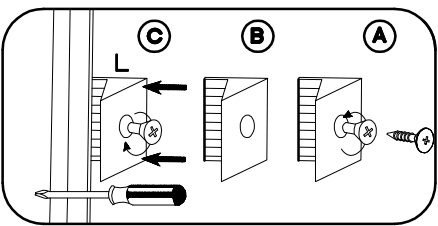
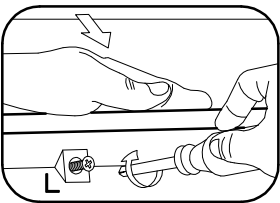
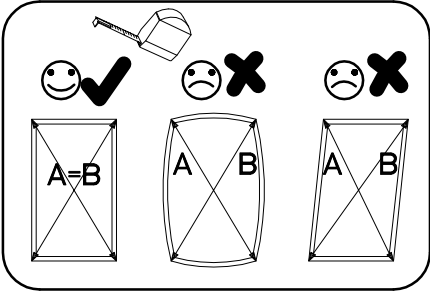
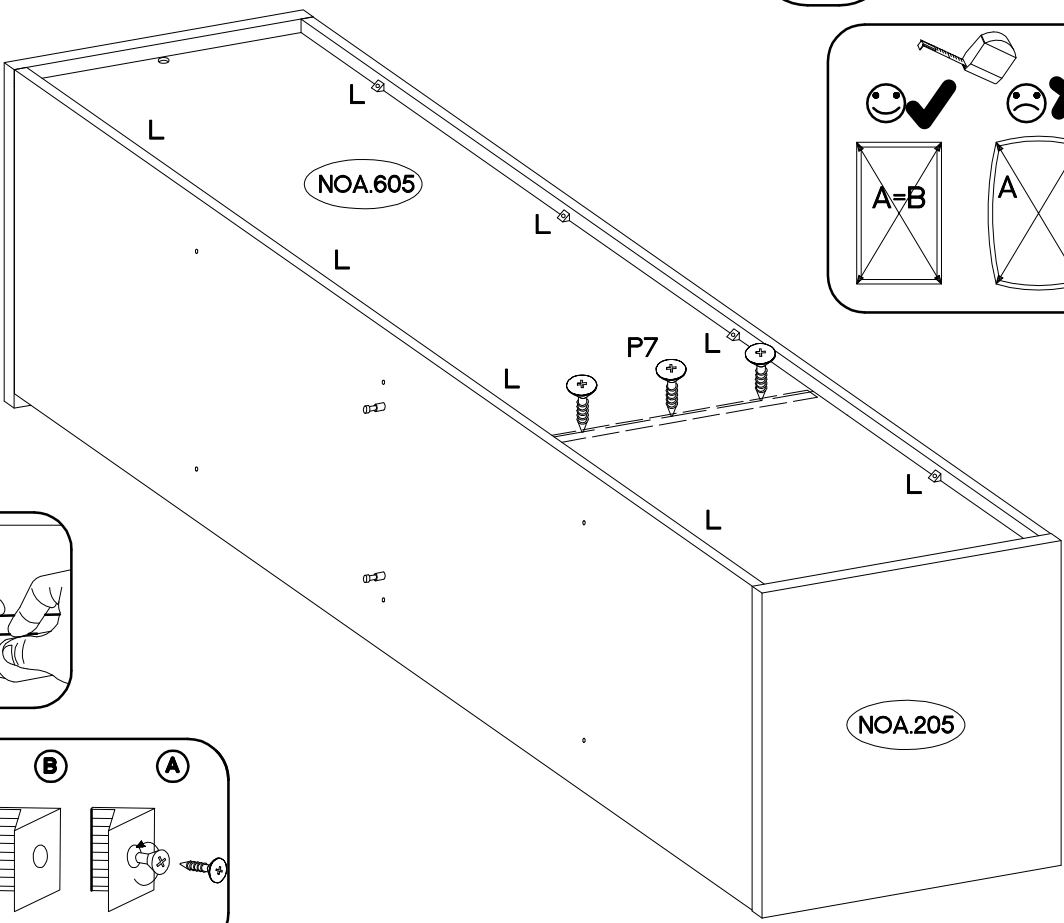
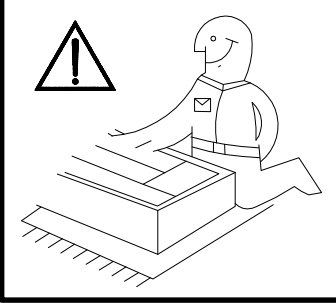
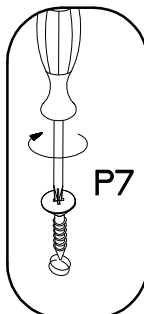

†3.0x20mm  P7 3	 L 8
---	---

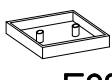

9

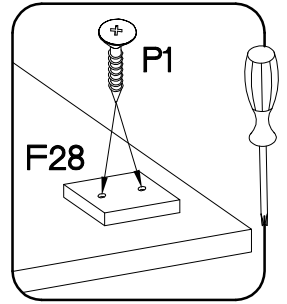
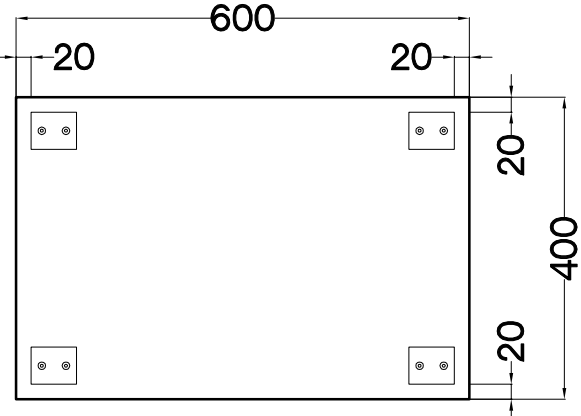
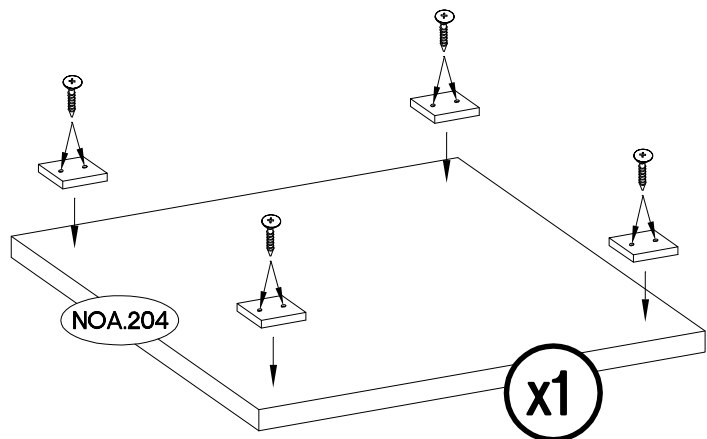
60x49x10  F28 4	†4.0x16mm  P1 8
--	--



$\varnothing 8 \times 30\text{mm}$  A 8	L=20mm  D2 8	$\varnothing 15/12\text{mm}$  C 10
--	---	---

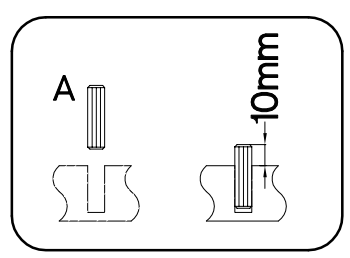
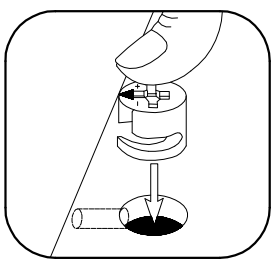
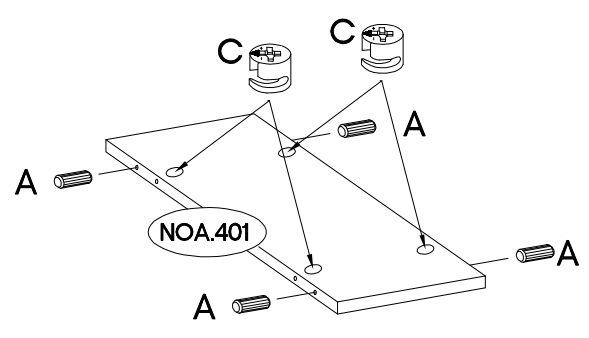
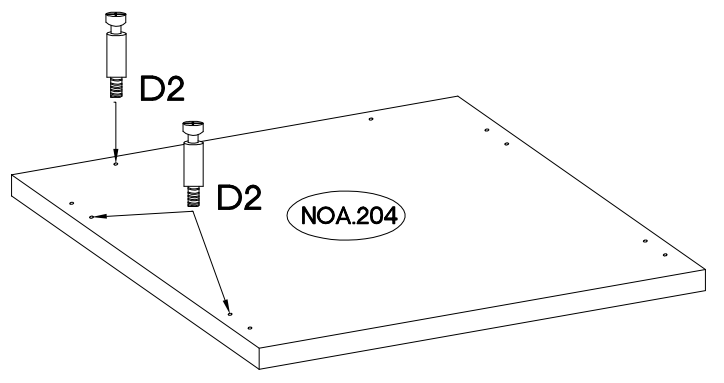
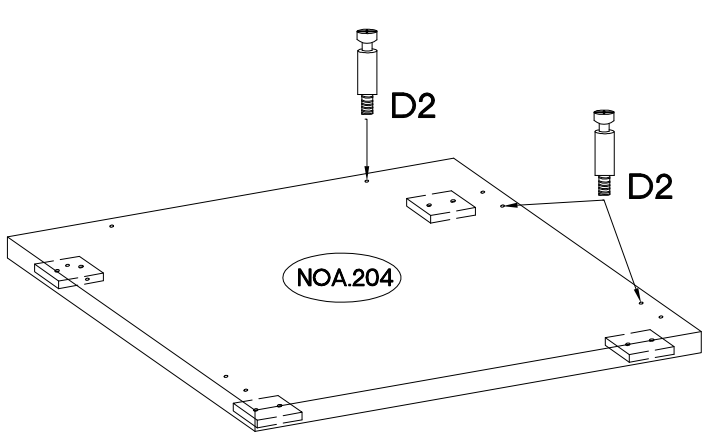
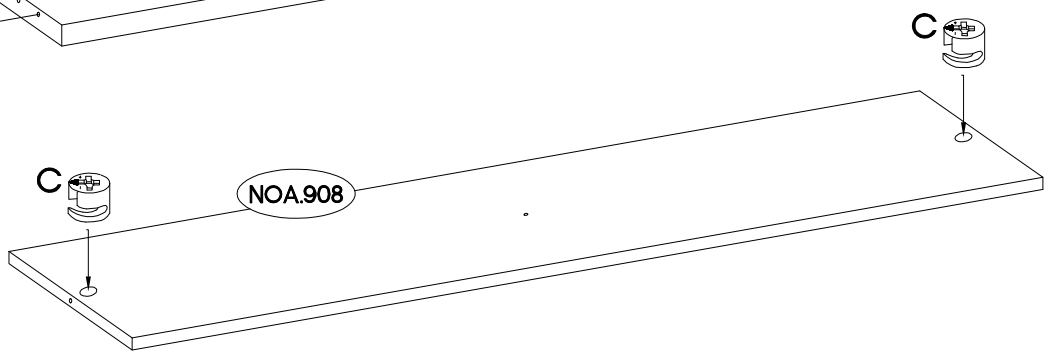
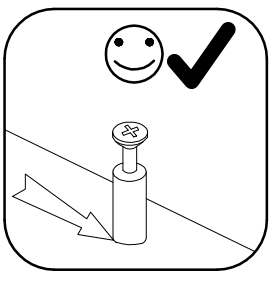
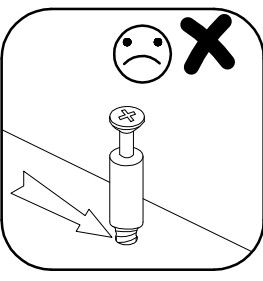
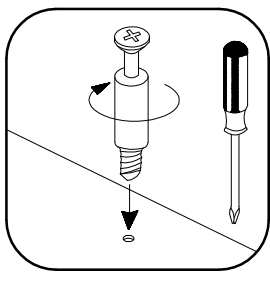

11

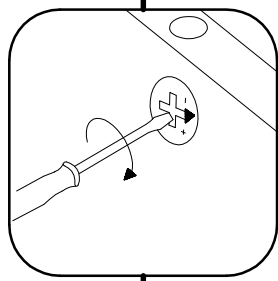
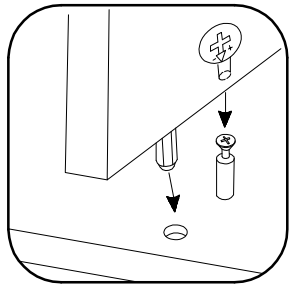
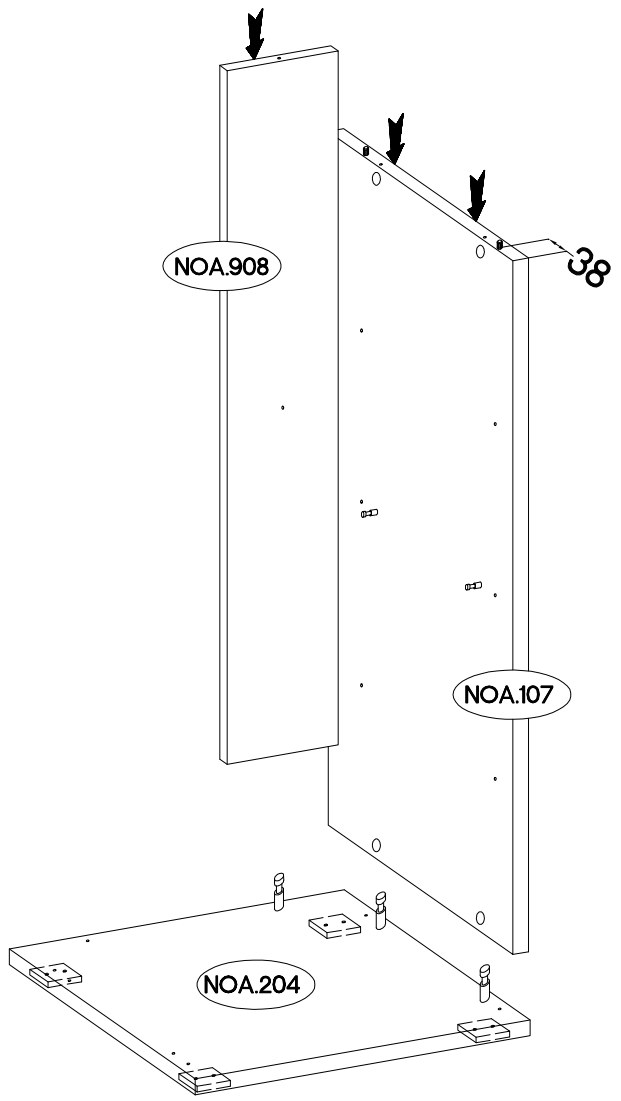

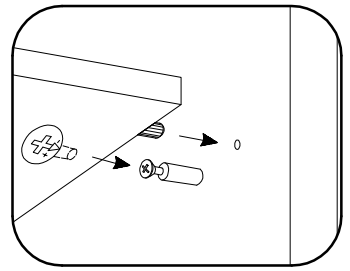
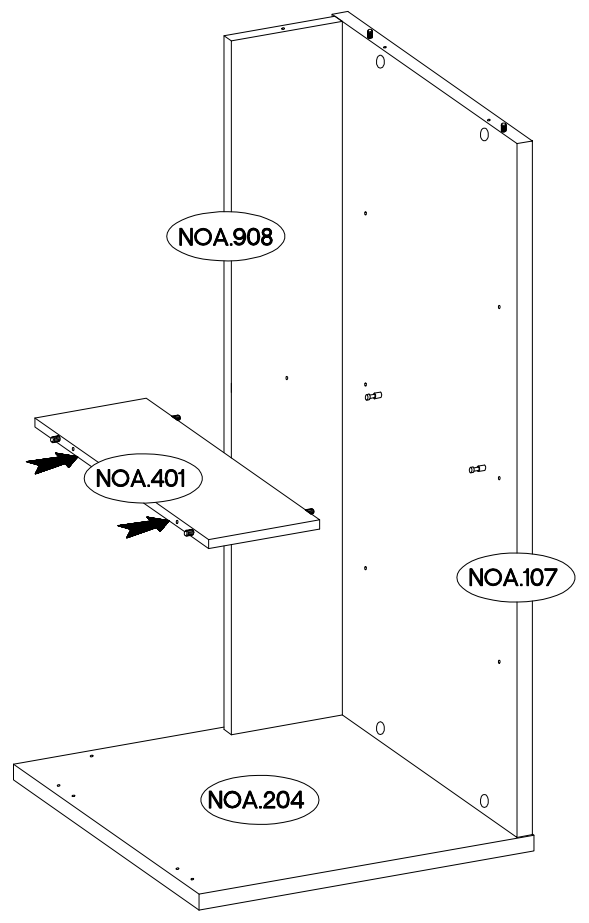

12

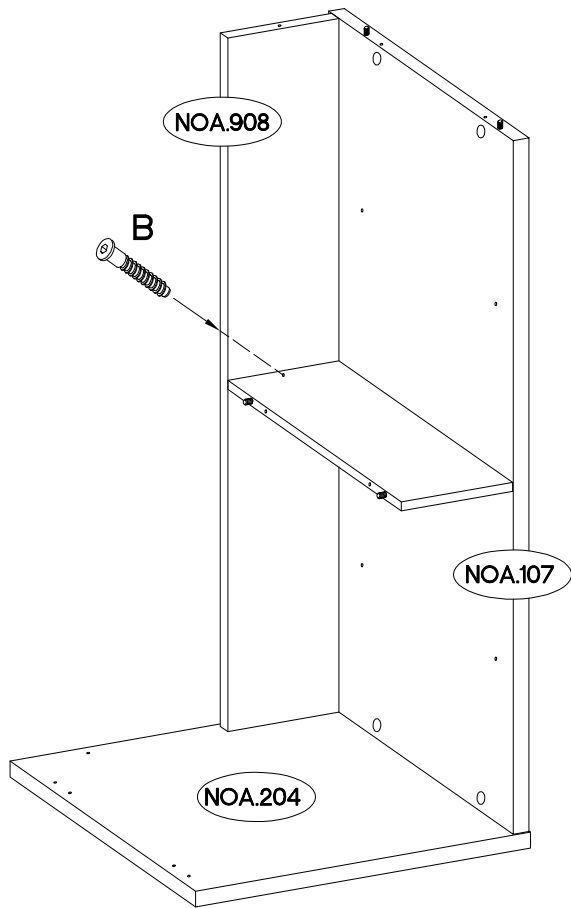

13

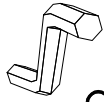

6,4 x 50mm		
		
B	O	E1
1	1	1

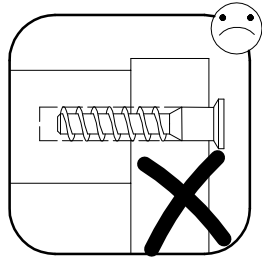
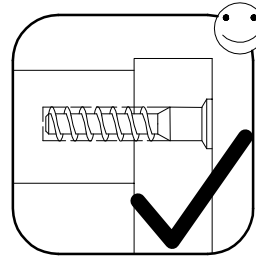
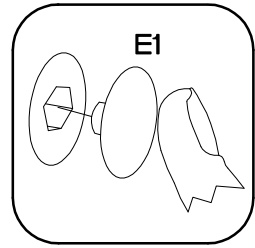
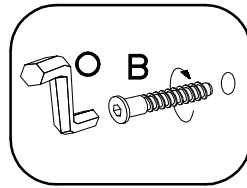

14

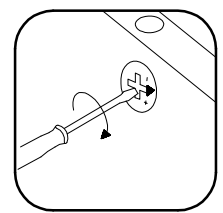
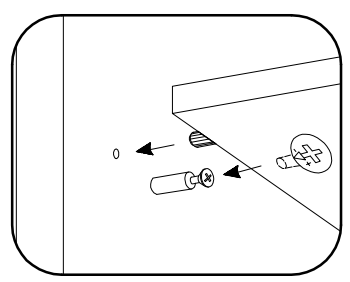
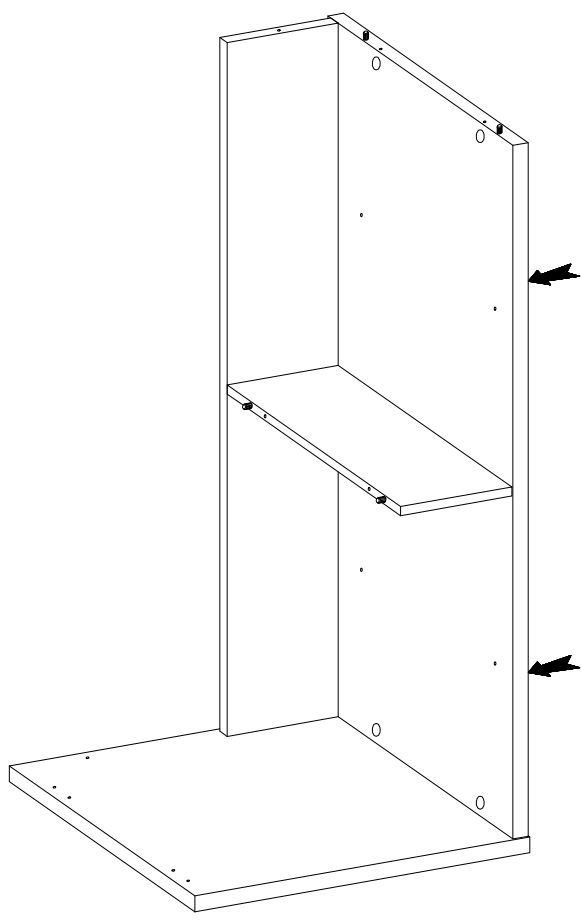
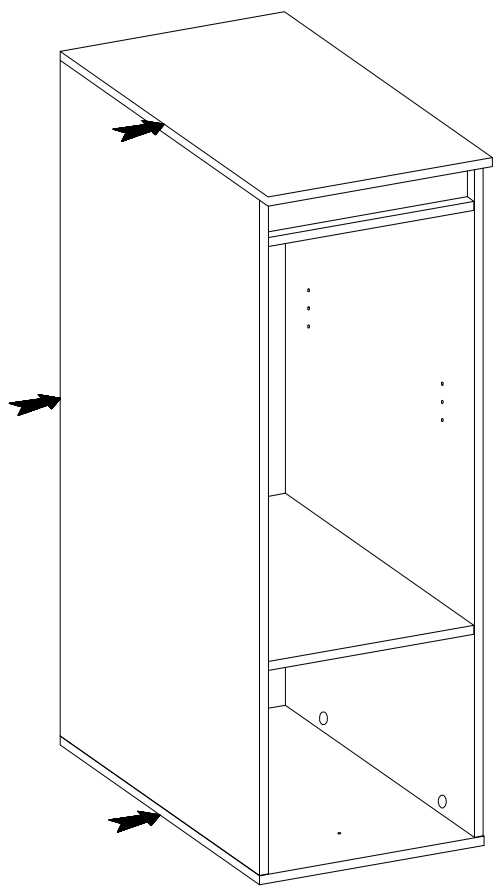

15

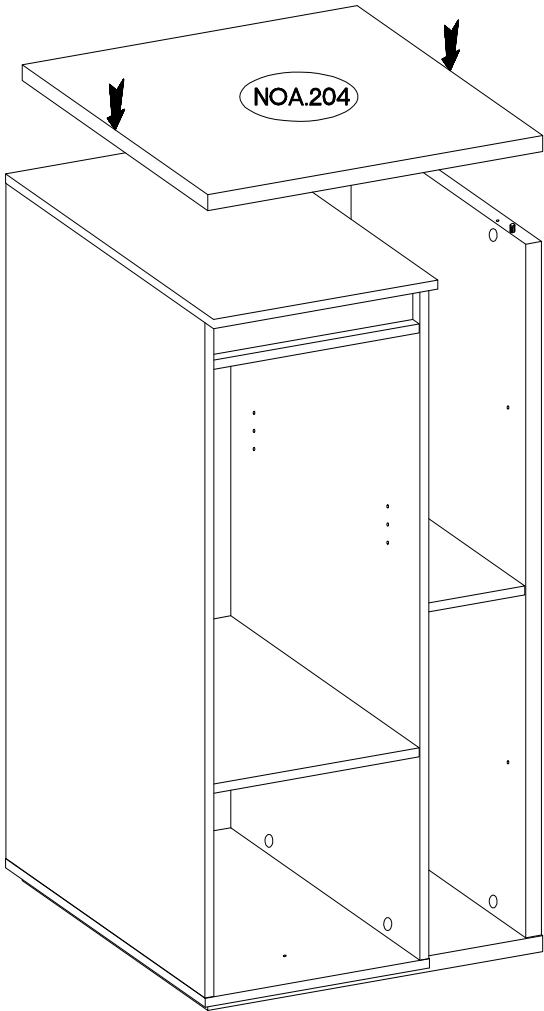

16

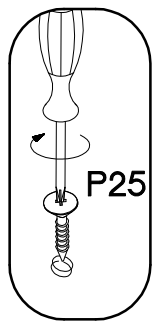
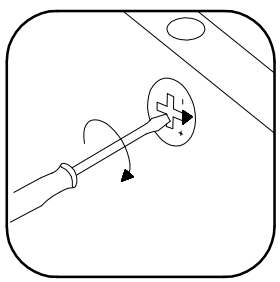
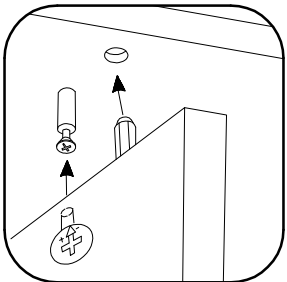
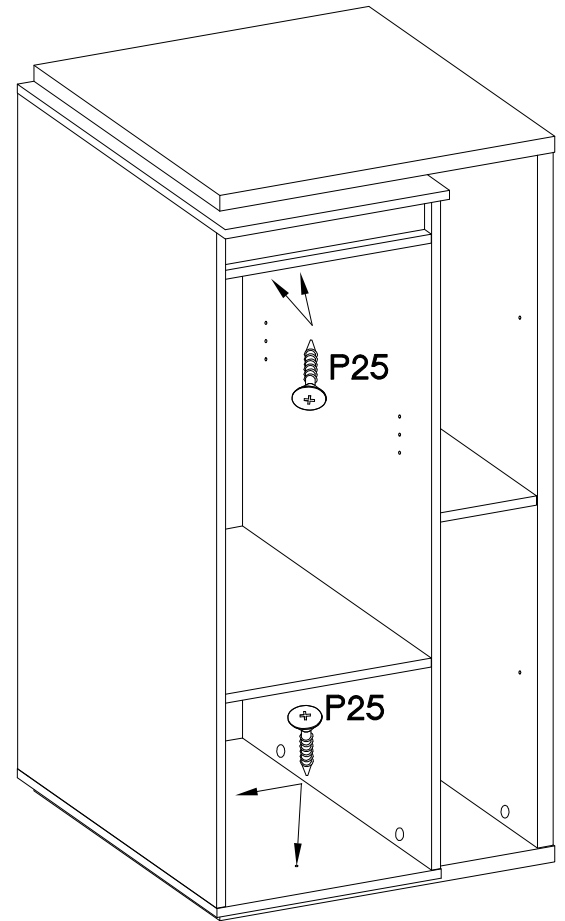

†3.5x25mm
 BLACK

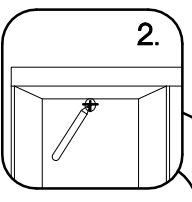
 P25
 4



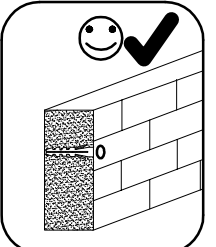
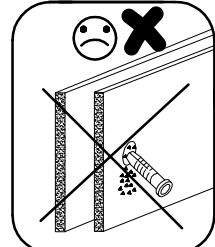
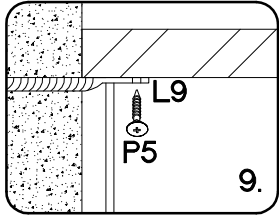
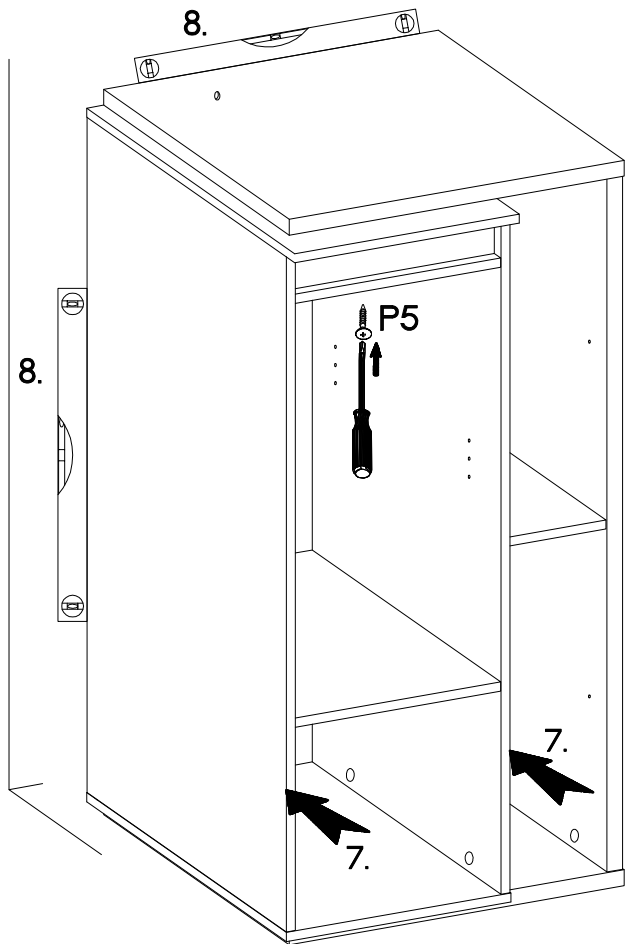
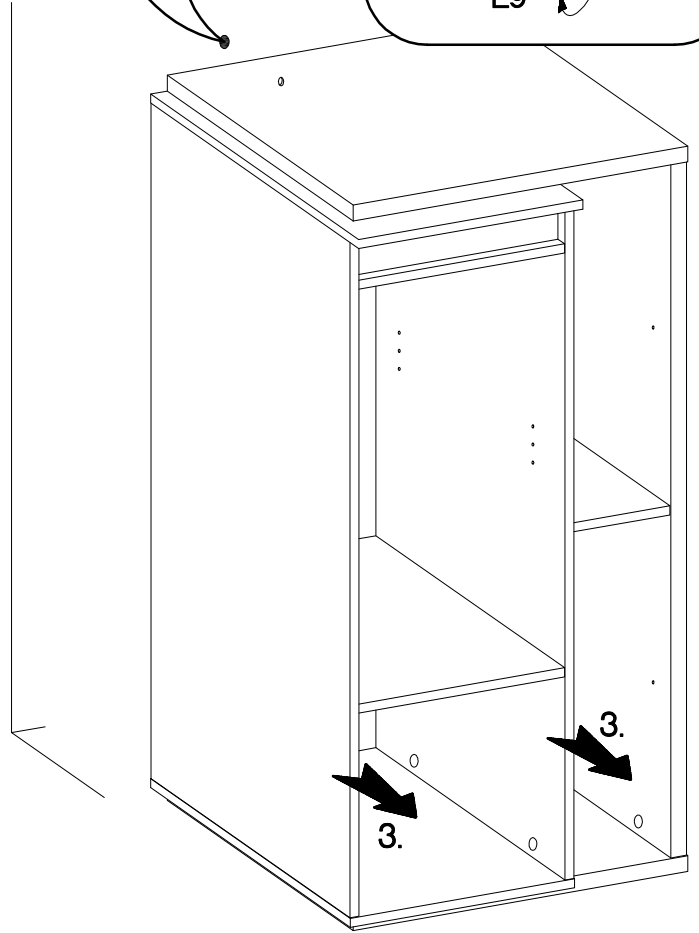
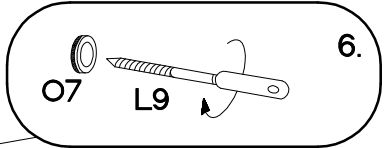
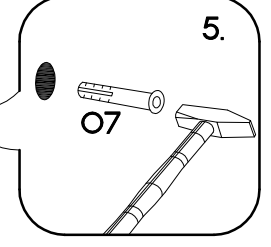
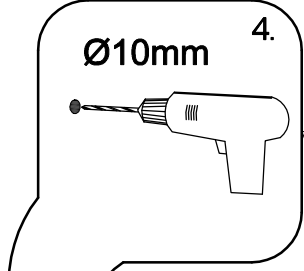
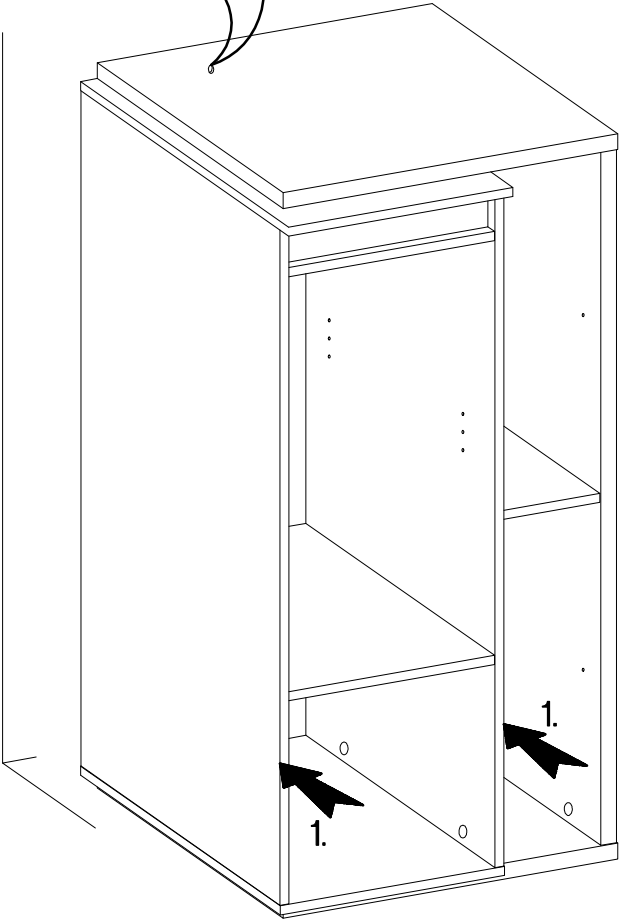



$\pm 10 \times 50 \text{mm}$ O7 1	 L9 1	$\pm 3.5 \times 13 \text{mm}$ P5 1
---	-------------	--

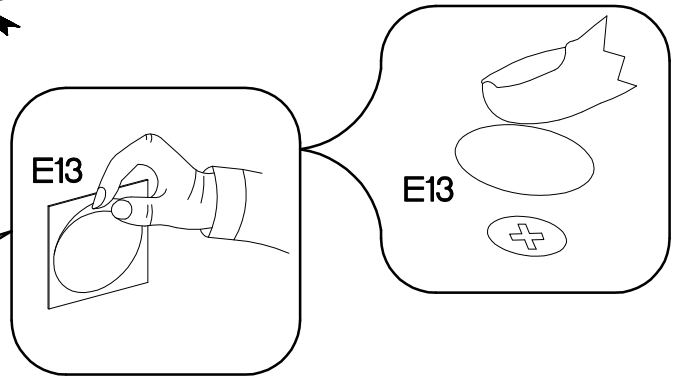
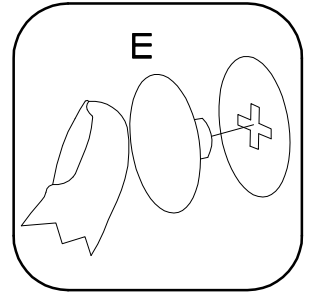
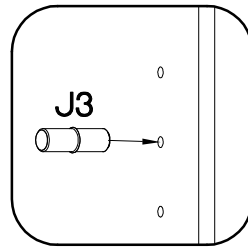
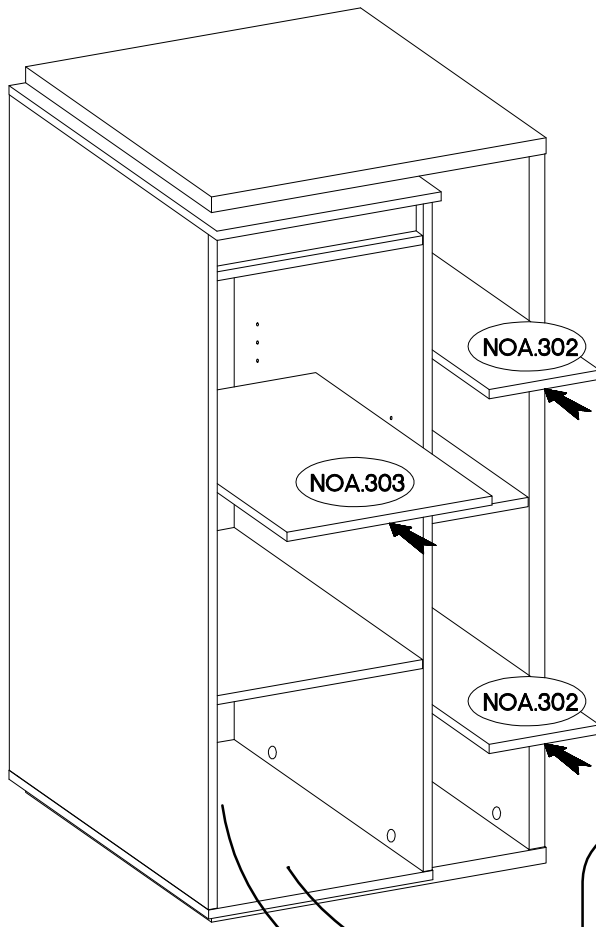

$\pm 5/16\text{mm}$  J3 12	ant. E 12	szar. E 10	± 14  E13 2
---	---------------------	----------------------	---



$\pm 35/0\text{mm}$  HG 3	$\pm 3.5 \times 13\text{mm}$  P5 6
--	---

